

# VHODNA VRATA



Izberite najboljše, ki traja



# Patentiran sistem proti krivljenju vrat **MPK 10**

Sistem MPK 10 vgrajujemo standardno v vsa vhodna vrata programa TREND in RUSTIKAL.

## INOVATIVNO

- Plod lastnega razvoja
- Odlično tesnenje
- V primeru krivljenja lahko vrata tudi po več letih izravnamo v ravnino z enostavnim vrtenjem vijaka, ki je na mehanizmu in s tem dosežemo, da se vratno krilo spet tesno prilega na podboj

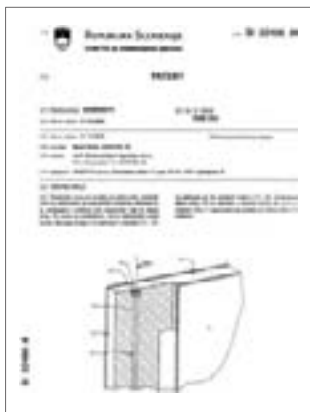

## VARNOSTNE KLJUČAVNICE **GU**

**G.U-SECURY MR 2**  
Standardno vgrajena ključavnica v vsa vhodna vrata INT

**G.U-SECURY Automatic**  
(doplačilo)

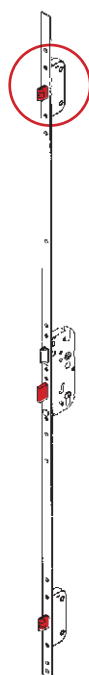

Vhodna vrata z vgrajeno ključavnico G.U-SECURY MR 2 ustrezajo varnostni stopnji WK 2 in WK 3

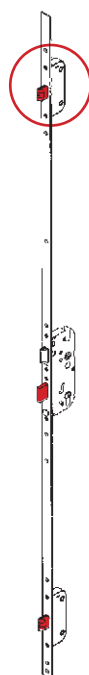

Vhodna vrata z vgrajeno ključavnico G.U-SECURY Automatic ustrezajo varnostni stopnji VdS razred A ter WK 2 in WK 3

## SMER ODPIRANJA

pogled od zunaj

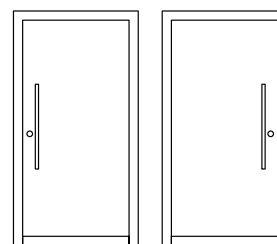

odpiranje NOTER:  
odpiranje VEN:

LEVA  
DESNA

DESNA  
LEVA

## IZVEDBE VRAT

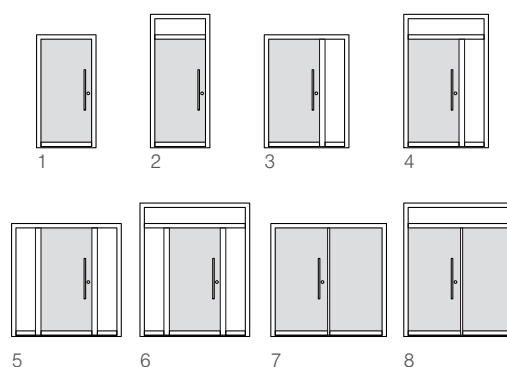

## BARVE

### POSTOPEK POVRŠINSKE OBDELAVE:

1x globinska zaščita, 1x osnovna zaščita, 1x vmesni nanos (Füller)  
1x ali 2x debeloslojna vodna lazura (odvisno od vrste lesa)



7 Rumena



8 Brezbarvna



9 Oranžna



10 Bor svetli



11 Bor temni

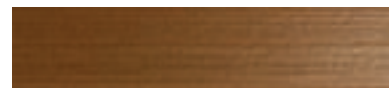

12 Hrast



13 Mahagonij



14 Tik



15 Oreh svetli



16 Oreh temni

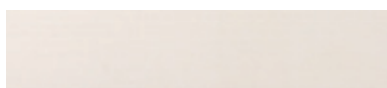

17 Bela



18 Macesen



19 Smreka temna



21 Bela lazura



RAL 9006



RAL 9007



RAL 7016 Antrazit



RAL 9006 metalik efekt



RAL 9007 metalik efekt



RAL 7016 Antrazit metalik efekt

## AMERIŠKI OREH

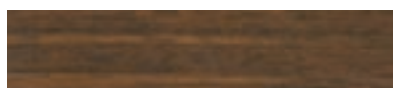

6 UV zaščita

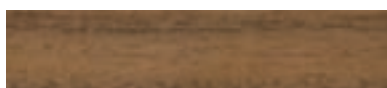

8 brezbarven



oljen

## STEKLA

### Skupina G1



Ornament  
504 beli



Činčila  
beli



Silvit  
beli



Katedral  
beli

### Skupina G2



Činčila  
rjavi



Gotik  
beli



Parsol

### Skupina G3

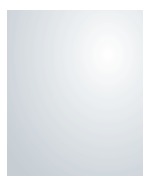

Satinato  
beli

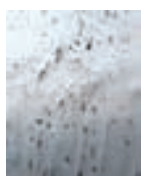

Altdeutsch  
beli



Mastercarree  
beli

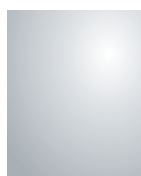

Stopsol  
prozorni, sivi

### Skupina DEKOR



Pave  
modri, beli



Uadi  
beli



Ton zeleni,  
modri, rdeči



**TREND 102**  
 steklo z motivom .....MS 751  
 kljuka..... E 4  
 prečka ..... RF 370/2  
 odkapni profil.....E 1000



**TREND 103**  
 steklo z motivom .....MS 751  
 držalo 55 cm .....D 3004  
 prečka ..... RF 370/2  
 odkapni profil.....E 1000



**TREND 180 P**  
 držalo 75 cm .....D 3006  
 odkapni profil.....E 2000



**TREND 135**  
 steklo.....SATINATO BELI  
 kljuka..... ALU 1  
 odkapni profil.....E 1000



**TREND 129**  
 steklo.....SATINATO BELI  
 držalo 55 cm .....D 3004  
 odkapni profil.....E 1000



**TREND 113**  
 steklo z motivom .....MS 11  
 držalo 32 cm .....D 3002  
 prečka ..... RF 370/2  
 odkapni profil.....E 1000



**TREND 190**  
 steklo.....SATINATO BELI  
 kljuka..... E 4  
 odkapni profil..... E 500  
 barva rdeča .....RAL 3005



**TREND 170**  
 steklo .....SATINATO BELI  
 držalo 75 cm .....D 3006  
 odkapni profil..... E 500

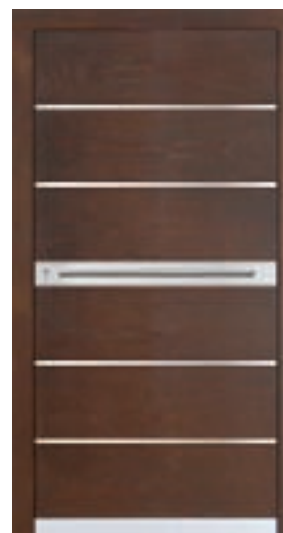

**TREND 175**  
 držalo prečno 75 cm ....D 3006  
 odkapni profil.....E 500

Vodilni v razvoju in kvaliteti  
lesenih vhodnih vrat v Sloveniji

TREND



**TREND 105**  
držalo 75 cm.....D 3006  
odkapni profil.....E 2000

**ST 100**  
steklo z motivom ..MS 822A/S  
zaščitna pločevina.....ST 500



**NADSVETLOBA**  
steklo.....PESKANO

**TREND 221**  
kljuka..... E 3  
odkapni profil..... E 2000  
barva bež.....RAL 1015

**ST 100**  
steklo z motivom.....MS 811/S



**ST 100/2**  
steklo z motivom.....MS 102/S

**TREND 125**  
steklo z motivom.....MS 102  
kljuka..... E 6  
odkapni profil..... E 500



**TREND 110 E16**  
steklo z motivom.....MS 162  
kljuka..... E 4  
odkapni profil..... E 2000

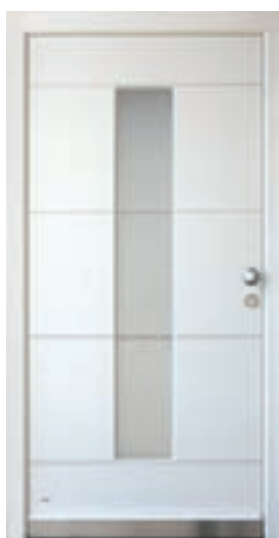

**TREND 110 U5**  
steklo z motivom.....MS 62  
gumb..... E 5  
odkapni profil..... E 2000



**ST 100**  
steklo z motivom  
MS 822A/S

**TREND 110 U16**  
steklo z motivom.....MS 110  
držalo 75 cm.....D 3006  
odkapni profil..... E 500

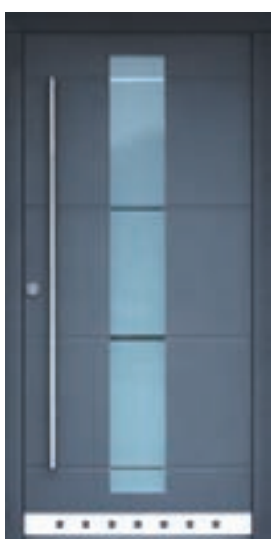

**TREND 111 U16**  
steklo z motivom.....MS 154  
držalo 150 cm.....D 3014  
odkapni profil..... E 3000



**TREND 115 U10**  
kljuka..... E 6  
odkapni profil..... E 500



**TREND 115 U5**  
držalo 75 cm.....D 3006  
odkapni profil..... E 500

**ST 100**  
steklo  
SATINATO BELI

Moderne linije

TREND



**TREND 185**  
steklo z motivom .....MS 164  
kljuka.....E 7  
odkapni profil.....E 500

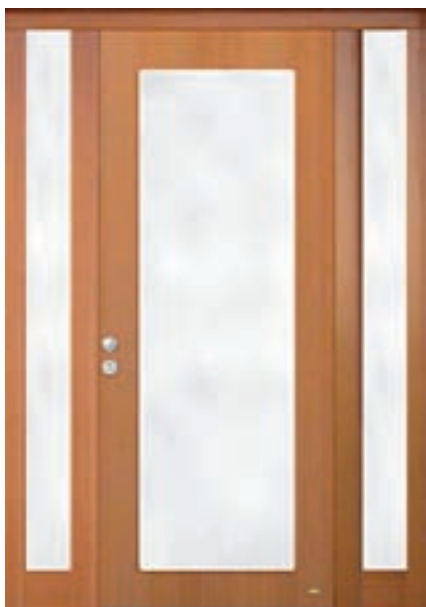

**ST 100 TREND 188 ST 100**  
 steklo.....SATINATO BELI  
 gumb..... E 5



višina do 300 cm



**ST 100 TREND 180**  
 steklo....SATINATO BELI držalo ..... 240 cm



**TREND 201**  
 steklo.....SATINATO BELI  
 držalo 150 cm.....D 3014



**TREND 146**  
 steklo.....SATINATO BELI  
 kljuka..... E 4  
 odkapni profil..... E 500



**TREND 165**  
 steklo.....SATINATO BELI  
 držalo 180 cm.....D 3016  
 odkapni profil..... E 2000



**TREND 319**  
 steklo z motivom .....MS 25R  
 držalo 37 cm.....D 2012



**TREND 131**  
 steklo.....SATINATO BELI  
 kljuka..... E 4  
 odkapni profil.....E 1000



**TREND 160**  
 steklo.....SATINATO BELI  
 držalo prečno 75 cm....D 3006  
 odkapni profil.....E 2000

Patentiran sistem proti  
krivljenju v vseh modelih

TREND



**TREND 121**

steklo.....PROZORNO  
držalo 38 cm.....D 1176  
odkapni profil .....E 500



**ST 100** **TREND 410**  
 steklo z motivom .....MS 880  
 držalo 32 cm .....D 3002

**ST 100**  
 steklo z motivom .....MS 869/S



**ST 100** **TREND 145**  
 steklo z motivom .....MS 822A/S  
 prečka .....RF 370/2

steklo .....PESKANO  
 kljuka .....E 4  
 odkapni profil .....E 1000



**TREND 150**  
 steklo z motivom .....MS 161/4  
 držalo 94 cm .....D 1122  
 odkapni profil .....E 2000

**ST 100**  
 steklo z motivom .....MS 164/S  
 zaščitna pločevina .....ST 500

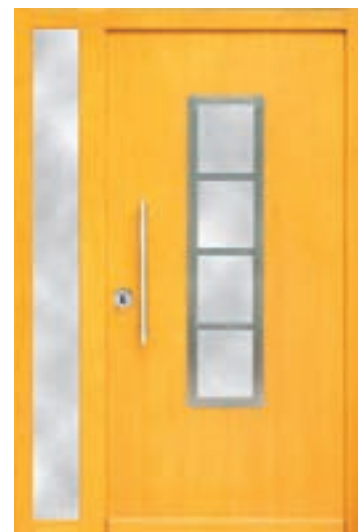

**ST 100** **TREND 106**  
 steklo .....SATINATO BELI  
 držalo 55 cm .....D 3004



**ST 100** **TREND 306**  
 steklo z motivom .....MS 822  
 držalo 55 cm .....D 3004  
 odkapni profil .....E 1000

**ST 100**  
 steklo z motivom .....MS 822/S



**ST 100** **TREND 176**  
 steklo z motivom .....MS 891  
 držalo 55 cm .....D 3004  
 odkapni profil .....E 1000

**ST 100**  
 steklo z motivom .....MS 369/S  
 prečka .....RF 370/2

Možnost izdelave velikih  
dimenzij do 130 x 300 cm

TREND



**TREND 120**  
steklo.....SATINATO BELI  
držalo 135 cm.....D 3012  
odkapni profil.....E 500



**TREND 155**  
 steklo.....PESKANO  
 držalo 135 cm.....D 3012  
 odkapni profil .....E 1000

**ST 100**  
 steklo z motivom .....MS 125/S



**TREND 130**  
 steklo.....SATINATO BELI  
 držalo 135 cm.....D 3012  
 odkapni profil.....E 1000  
 podboj RAL 7035 / krilo RAL 5014



**TREND 122**  
 steklo fuzijsko .....MF 122  
 držalo 55 cm.....D 3004  
 prečka .....RF 370/3



**TREND 128**  
 steklo.....SATINATO BELI  
 držalo 55 cm.....D 3004



**TREND 126**  
 steklo.....SATINATO BELI  
 držalo 55 cm.....D 3004  
 odkapni profil.....E 1000



**TREND 151**  
 steklo fuzijsko .....MF 621  
 držalo 45 cm.....D 1222  
 prečka .....RF 370/3

Vrata za pasivne hiše  
možnost izvedbe pri določenih modelih

TREND



**TREND 220**  
steklo z motivom .....MS 311  
držalo 83 cm.....D 1142  
odkapni profil.....E 1000

**ST 100**  
steklo z motivom .....MS 311/S



**HT 806**  
kljuka.....MB 1

**ST 200**  
steklo.....SILVIT beli

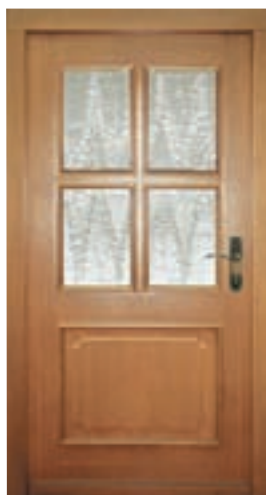

**HT 384**  
kljuka.....MB 1  
steklo.....ČINČILA rjavi



**HT 902**  
kljuka.....MB 1  
steklo.....SILVIT beli



**HT 306**  
kljuka.....MB 1

**ST 306**  
steklo  
KATEDRAL beli



**ST 611**  
poštna loputa  
MEĐENINA sijaj

**HT 611**  
steklo.....ČINČILA beli  
kljuka.....MB 1



**ST 200** **HT 368**  
steklo.....SILVIT beli  
kljuka.....M 1



**HT 303**  
steklo.....ČINČILA beli  
kljuka.....ALU 1



**HT 621**  
steklo.....SILVIT beli  
kljuka.....MB 1



**HT 623**  
steklo.....SATINATO beli  
bunka.....E 5



**HT 573**  
steklo.....SATINATO beli  
držalo 75 cm.....D 3006  
odkapni profil.....E 2000

Domačnost in toplina

RUSTIKAL



**HT 603**  
steklo.....SILVIT beli  
kijuka.....MB 1

# GARAŽNA VRATA

KLASIČNA DVOKRILNA do dim. 250x300 cm

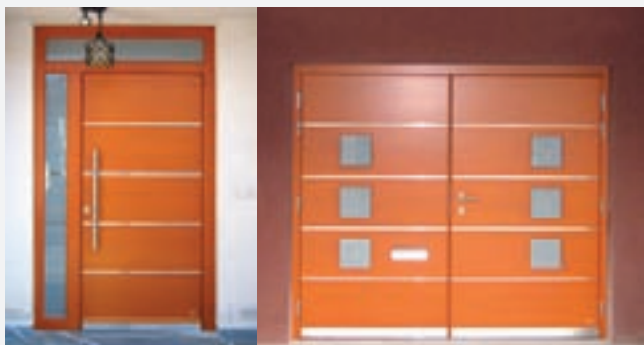

TREND 105

GV 105/3S



TREND 185

GV 185



HT 623

GV 623



GV 122



TREND 410

GV 115

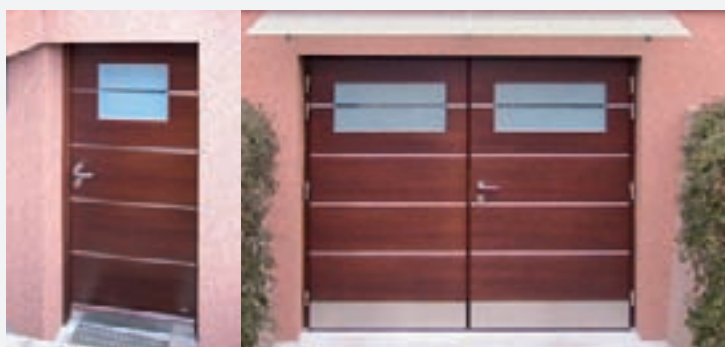

TREND 105/1S

GV 105/1S



TREND 135

GV 180 E



GV 114/1S

# Usklajen videz vhodnih in garažnih vrat

## SEKCIJSKA DVIŽNA do dim. 300x300 cm



pogled znotraj

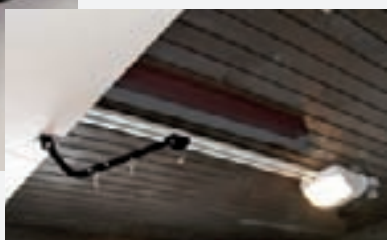

motor za avtomatski dvig

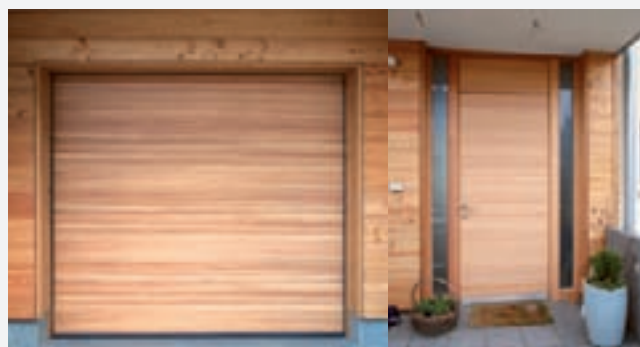

SGV 115

TREND 115

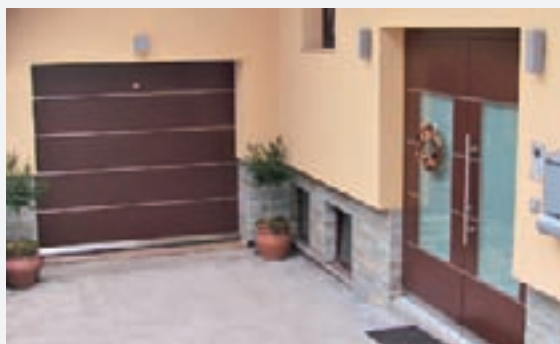

SGV 105

TREND 185/1



SGV 105

TREND 105



SGV 2P/4S



SGV 623

HT 623



SGV 105

TREND 105



SGV 105 E

TREND 105

# LES-ALUMINIJ

Vsi modeli vrat v programu TREND so izvedljivi v LES-ALU izvedbi.

Določeni detajli v LES-ALU izvedbi se razlikujejo od detajlov v leseni izvedbi.

## Tehnične lastnosti

**Les:** smreka, macesen, hrast, oreh, meranti

**Aluminij obloga:** sistem Alto Nova, proizvajalca Stemeseder, Avstrija



**Dimenzija enokrilnih vrat:**

Standardno do 110 x 220 cm

Maksimalno do 130 x 250 cm

**Steklo:**

troslojno izolacijsko  $U_g=1.1 \text{ W/m}^2\text{K}$

z doplačilom  $U_g=0.7, 0.6$  ali  $0.5 \text{ W/m}^2\text{K}$

**Ključavnica varnostna** s tritočkovnim zaklepanjem

**Nasadila:**

trije kosí  $\varnothing 20 \text{ mm}$ , s trismerno regulacijo

**Tesnilo:** trojno, spodaj dvojno

**Prag:** termoizolacijski BKW 70

**Površinska obdelava lesa:**

Debeloslojna vodna lazura po INT barvni karti

ali pokrivna vodna barva po RAL ali NCS barvni karti

**Površinska obdelava aluminija:**

Prašno lakiran po standardu RAL RG 631



ZUNANJA OBLOGA IZ ALUMINIJA ZAGOTAVLJA DOLGOROČNO ZAŠČITO BREZ VZDRŽEVANJA.



TREND 105 LA



TREND 111 LA



TREND 115 u16 LA



TREND 125 LA



TREND 150 LA



TREND 165 LA



TREND 180 LA



TREND 220 LA

## PROFIL VV 95 LA

ENERGETSKO VARČNA VRATA

**Ud=0.81 W/m<sup>2</sup>K**

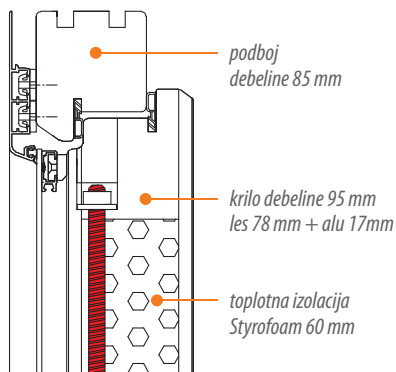

## PROFIL VV 115 LA

PASIVNA VRATA

**Ud=0.70 W/m<sup>2</sup>K**

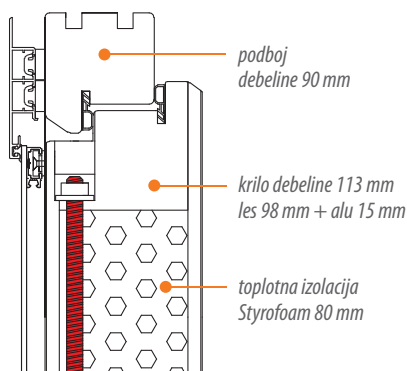

## PROFIL VV 85 LA

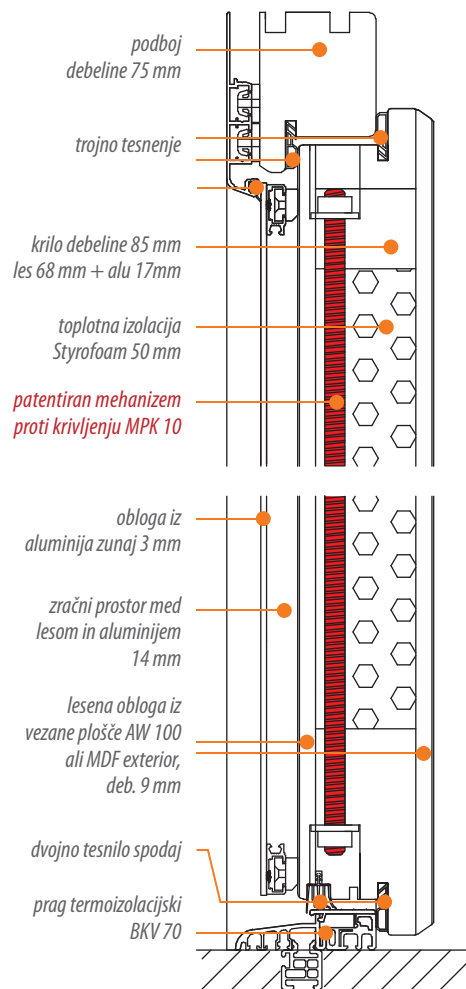

Toplotna prehodnost vrat: VV 85 LA - glej stran 20 / Profil VV 68  
VV 95 LA - glej stran 22 / Profil VV 78  
VV 115 LA - glej stran 23 / Profil VV 98

## BARVE ALUMINIJA

RAL mat  
standard



GS premium  
standard



GS PED  
standard

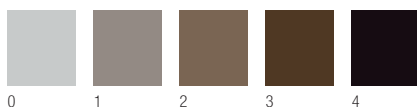

ANTICO  
metalik efekt



LESNI  
DEKOR

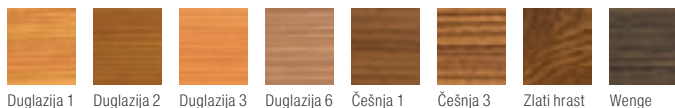

Po ponudbi: RAL sijaj in vse ostale barve, ki niso navedene v barvni karti Alto Nova

# VHODNA VRATA STANDARD

## PROFIL VV 68

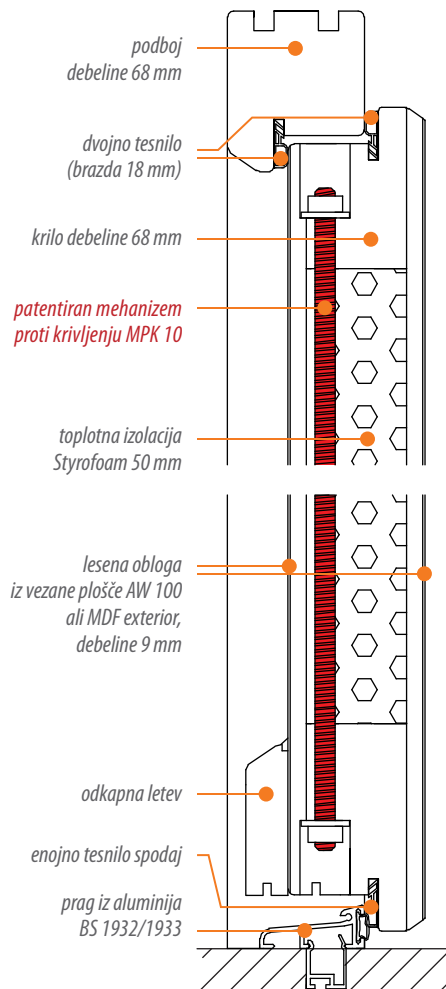

### Tehnične lastnosti

Vrata PROFIL VV 68 izdelujemo v programu TREND in RUSTIKAL

Vrste lesa: smreka, macesen, hrast, oreh, meranti

Dimenzija enokrilih vrat (izdelava po meri):

Standardno do 110 x 220 cm

Maksimalno do 130 x 300 cm

Steklo: dvoslojno izolacijsko  $U_g=1.1 \text{ W/m}^2\text{K}$

Z doplačilom: troslojno izolacijsko  $U_g=0.7$  ali  $0.6 \text{ W/m}^2\text{K}$

Ključavnica varnostna s tritočkovnim zaklepanjem

Nasadila: trije kosi  $\varnothing 20 \text{ mm}$  s trismerno regulacijo

Tesnilo: dvojno, brazda 18 mm, spodaj enojno

ALU prag: BS 1932 za novogradnjo ali obnovo

Z doplačilom: termoizolacijski prag BKV 70 in dvojno tesnilo spodaj

Površinska obdelava lesa:

Debeloslojna vodna lazura po INT barvni karti ali pokrivna vodna barva po RAL ali NCS barvni karti

Steklitvene letvice pri vratih programa TREND:

standardna izvedba A, B, C, D, E (odvisno od modela vrat)

Steklitvene letvice pri vratih programa RUSTIKAL:

standardna izvedba B, C, za doplačilo A, F

Patentiran mehanizem proti krivljenju MPK 10

Kovinska ojačitev pri ključavnici (opcija)

### Toplotna prehodnost vrat PROFIL VV 68 - program TREND

V izračunu so upoštevane dimenzije:

vhodna vrata 110 x 220 cm, st. svetloba 40 x 220 cm, steklo v krilu 22 x 150 cm



	prag	kovinska ojačitev pri ključavnici	steklo ( $W/m^2K$ )	Ud ( $W/m^2K$ )
	BS 1932 BKV 70	DA NE	/ /	<b>1.1</b> <b>0.86</b>
	BS 1932 BKV 70	DA NE	0.6 0.6	<b>1.0</b> <b>0.95</b>
	BS 1932 BKV 70	DA NE	0.6 0.6	<b>1.2</b> <b>0.93</b>
	BS 1932 BKV 70	DA NE	0.6 0.6	<b>1.1</b> <b>1.1</b>

# VHODNA VRATA S KOVINSKO SREDICO

## PROFIL VV 74

### Toplotna prehodnost vrat PROFIL VV 74

V izračunu so upoštevane dimenzije:  
vhodna vrata 110 x 220 cm, st. svetloba 40 x 220 cm,  
steklo v krilu 22 x 150 cm

	prag	kovinski okvir po 4 straneh	U <sub>g</sub> (W/m <sup>2</sup> K)	U <sub>d</sub> (W/m <sup>2</sup> K)
	BKV 70	DA	/	<b>1.0</b>
	BKV 70	DA	0.5	<b>1.0</b>
	BKV 70	DA	0.5 0.7 1.1	<b>1.1</b> <b>1.1</b> <b>1.2</b>

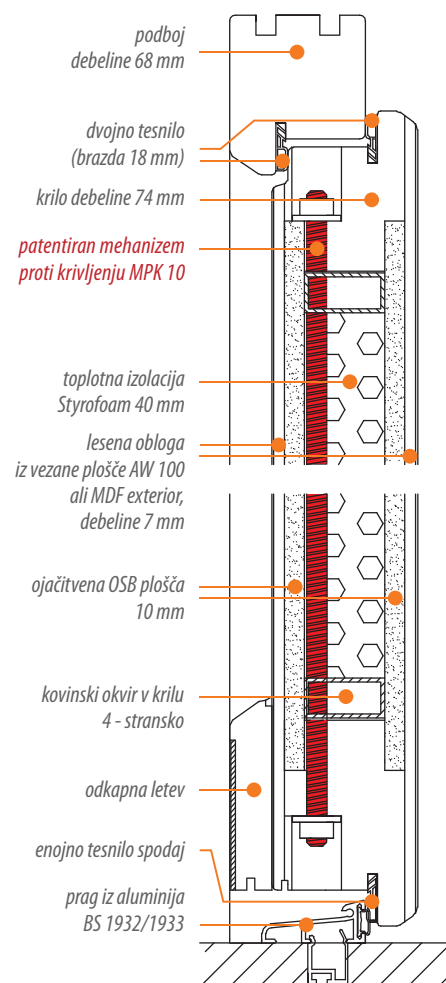

Kovinsko sredico standardno vgrajujemo v vsa vhodna vrata PROFIL VV 74.

### Tehnične lastnosti

Vrata PROFIL VV 74 izdelujemo v programu TREND in RUSTIKAL

Vrste lesa: smreka, macesen, hrast, oreh, meranti

Dimenzija enokrilnih vrat (izdelava po meri):

Standardno do 110 x 220 cm

Maksimalno do 130 x 300 cm

Steklo: dvoslojno izolacijsko U<sub>g</sub>=1.1 W/m<sup>2</sup>K

Z doplačilom: troslojno izolacijsko U<sub>g</sub>=0.7, 0.6 ali 0.5 W/m<sup>2</sup>K

Ključavnica varnostna s tritočkovnim zaklepanjem

Nasadila: trije kosi ø20 mm s trismerno regulacijo

Tesnilo: dvojno, brazda 18 mm, spodaj enojno

ALU prag: BS 1932 za novogradnjo ali obnovo

Z doplačilom: termoizolacijski prag BKV 70 in dvojno tesnilo spodaj

Površinska obdelava lesa:

Debeloslojna vodna lazura po INT barvni karti ali pokrivna vodna barva po RAL ali NCS barvni karti

Steklitvene letvice pri vratih programa TREND:

standardna izvedba A, B, C, D, E (odvisno od modela vrat)

Steklitvene letvice pri vratih programa RUSTIKAL: standardna izvedba A, F

Patentiran mehanizem proti krivljenju MPK 10

Kovinski okvir v krilu po štirih straneh

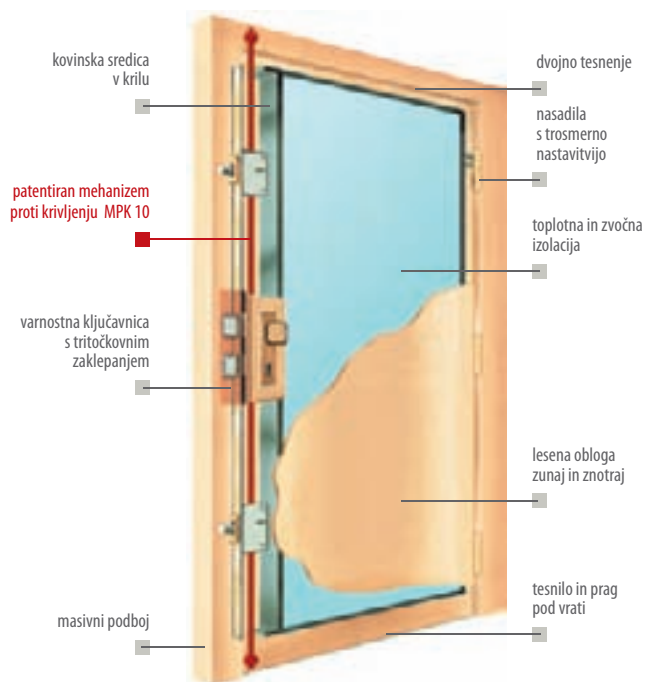

# ENERGETSKO VARČNA VRATA

## PROFIL VV 78

**Ud=0.81 W/m<sup>2</sup>K**

### Tehnične lastnosti

Vrata PROFIL VV 78 izdelujemo v programu TREND

Vrste lesa: smreka, macesen, hrast, oreh, meranti

Dimenzija enokrilnih vrat (izdelava po meri):

Standardno do 110 x 220 cm

Maksimalno do 130 x 300 cm

Steklo: dvoslojno izolacijsko Ug=1.1 W/m<sup>2</sup>K

Z doplačilom: troslojno izolacijsko Ug=0.7, 0.6 ali 0.5 W/m<sup>2</sup>K

Ključavnica varnostna s tritočkovnim zaklepanjem

Nasadila: trije kosi ø20 mm s trismerno regulacijo

Tesnilo: dvojno, brazda 18 mm

Prag: termoizolacijski BKV 70 za novogradnjo ali obnovo

Površinska obdelava lesa:

Debeloslojna vodna lazura po INT barvni karti

ali pokrivna vodna barva po RAL ali NCS barvni karti

Steklitvena letvica:

standardna izvedba A, B, C, D, E (odvisno od modela vrat)

Patentiran mehanizem proti krivljenju MPK 10

Kovinska ojačitev pri ključavnici (opcija)

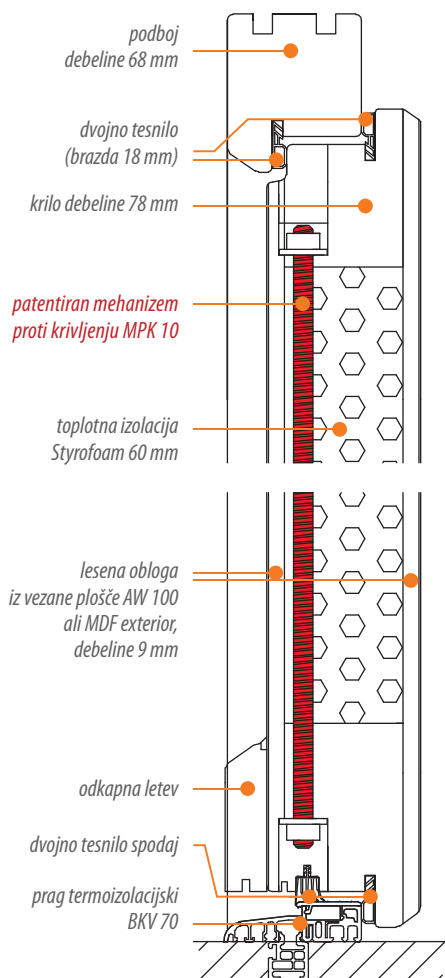

### Toplotna prehodnost vrat PROFIL VV 78

V izračunu so upoštevane dimenzije:

vhodna vrata 110 x 220 cm, st. svetloba 40 x 220 cm, steklo v krilu 22 x 150 cm

	prag	kovinska ojačitev pri ključavnici	steklo (W/m <sup>2</sup> K)	Ud (W/m <sup>2</sup> K)
	BKV 70	NE	/	<b>0.81</b>
	BKV 70	NE	0.5 0.7	<b>0.90</b> <b>0.92</b>
	BKV 70	NE	0.7	<b>0.89</b>
	BKV 70	NE	0.7	<b>0.96</b>

# PASIVNA VRATA

## PROFIL VV 98

**Ud=0.70 W/m<sup>2</sup>K**

### Tehnične lastnosti

Vrata PROFIL VV 98 izdelujemo v programu TREND

Vrste lesa: smreka, macesen, hrast, oreh, meranti

Dimenzija enokrilnih vrat (izdelava po meri):

Standardno do 110 x 220 cm

Maksimalno do 130 x 300 cm

Steklo: dvoslojno izolacijsko Ug=1.1 W/m<sup>2</sup>K

Z doplačilom: troslojno izolacijsko Ug=0.7, 0.6 ali 0.5 W/m<sup>2</sup>K

Ključavnica varnostna s tritočkovnim zaklepanjem

Nasadila: trije kosi ø20 mm s trismerno regulacijo

Tesnilo: dvojno, brazda 18 mm

Prag: termoizolacijski BKV 70 za novogradnjo ali obnovo

Površinska obdelava lesa:

Debeloslojna vodna lazura po INT barvni karti

ali pokrivna vodna barva po RAL ali NCS barvni karti

Steklitvena letvica:

standardna izvedba A, B, C, D, E (odvisno od modela vrat)

Patentiran mehanizem proti krivljenju MPK 10

Kovinska ojačitev pri ključavnici (opcija)

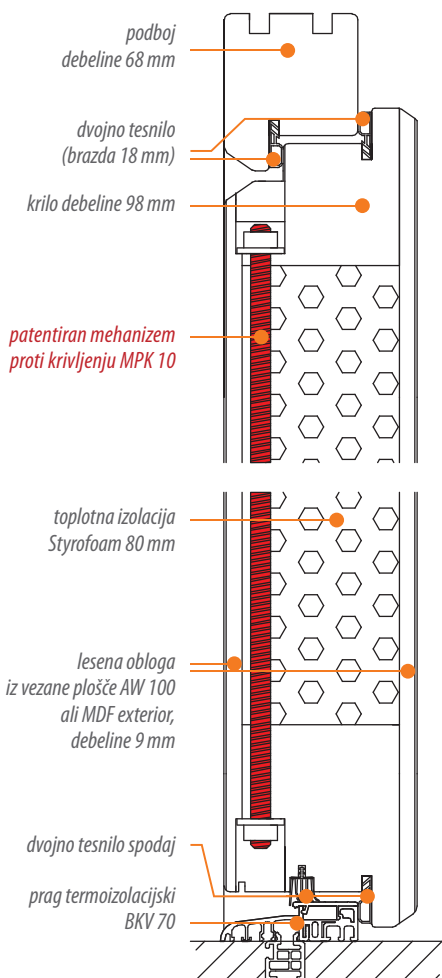

### Toplotna prehodnost vrat PROFIL VV 98

V izračunu so upoštevane dimenzije:

vhodna vrata 110 x 220 cm, st. svetloba 40 x 220 cm, steklo v krilu 22 x 150 cm

	prag	kovinska ojačitev pri ključavnici	steklo (W/m <sup>2</sup> K)	Ud (W/m <sup>2</sup> K)
	BKV 70	NE	/	<b>0.70</b>
	BKV 70	NE	0.6 0.7	<b>0.75</b> <b>0.80</b>
	BKV 70	NE	0.7	<b>0.77</b>
	BKV 70	NE	0.7	<b>0.86</b>

# PODBOJ IN KRILO V ISTI RAVNINI - skrita nasadila

## PROFIL VV 78 B

ENERGETSKO VARČNA VRATA

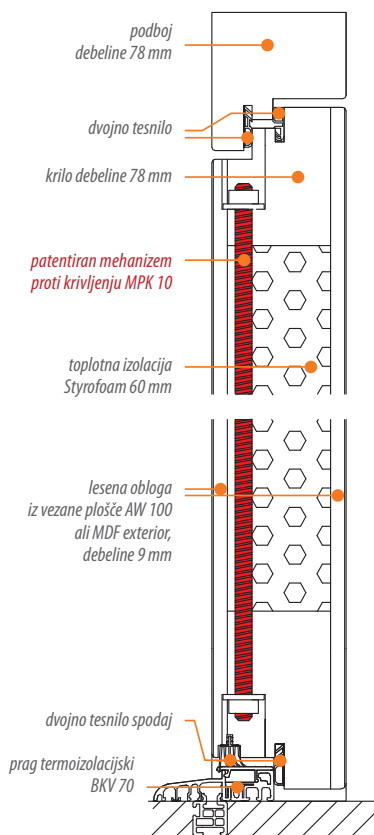

## PROFIL VV 98 B

PASIVNA VRATA

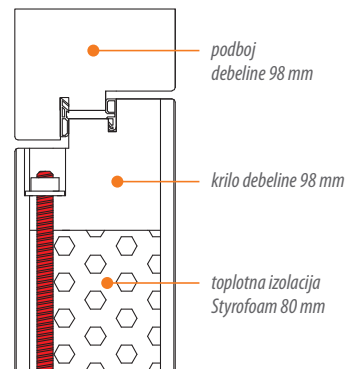

## PROFIL VV 74 B

VRATA S KOVINSKO SREDICO

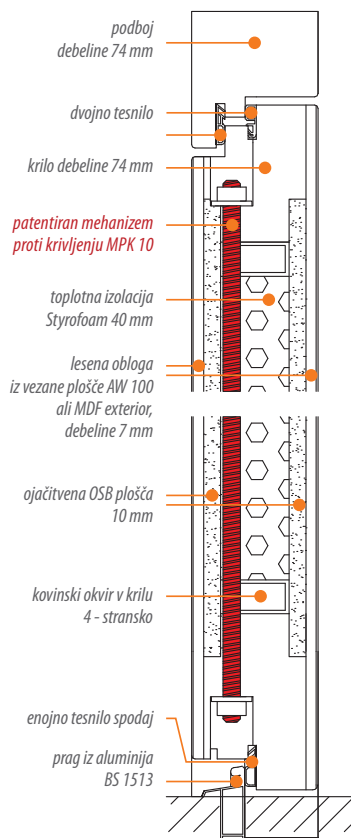

Tehnične lastnosti in toplotna prehodnost vrat:

VV 78 B: glej stran 22

VV 98 B: glej stran 23

VV 74 B: glej stran 21

## IZVEDBE STEKLITVENIH LETVIC

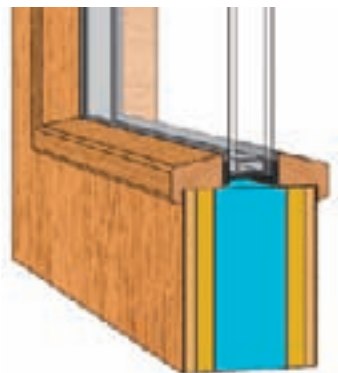

A  
letvica obojestransko  
gladka

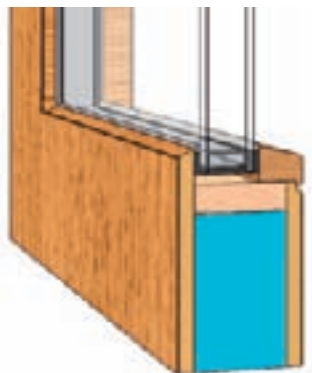

B  
letvica znotraj  
zamik stekla 10 ali 12 mm na zunanji strani

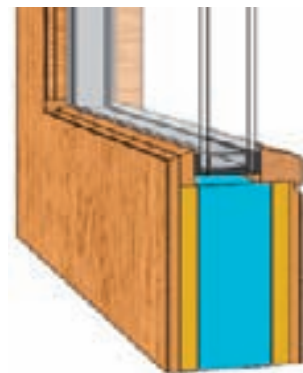

C  
letvica znotraj  
zamik stekla 22 mm na zunanji strani

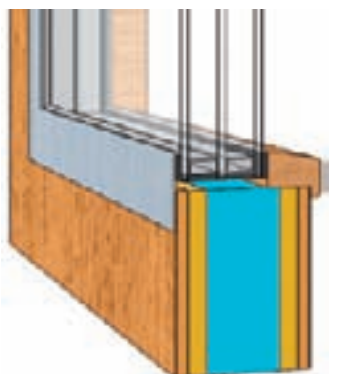

D  
okvirček iz nerjavečega jekla  
na zunanji strani

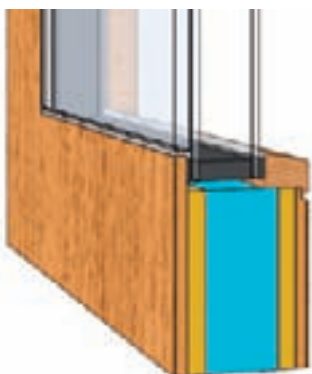

E  
steklo v ravnini s krilom  
na zunanji strani

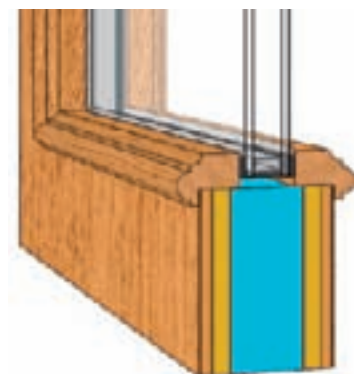

F  
letvica obojestransko  
rustikal

## ODKAPNI PROFILI



Lesen



E 500



E 1000



E 1500

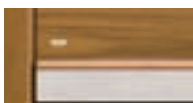

E 2000



E 3000

## POŠTNE LOPUTE



ALU F1  
obojestransko  
dim.: 270 x 85 mm  
reža: 230 x 40 mm



INOX BT26  
obojestransko  
dim.: 275 x 80 mm  
reža: 230 x 40 mm



KROM  
mat  
dim.: 252 x 78 mm  
reža: 202 x 42 mm



MEDENINA  
brunirana  
dim.: 252 x 78 mm  
reža: 190 x 40 mm



MEDENINA  
sijaj  
dim.: 252 x 78 mm  
reža: 190 x 40 mm



LESEN POKROV  
notranji del  
dim.: 250 x 100 mm  
reža: 200 x 60 mm

## IZVEDBE PRAGOV:

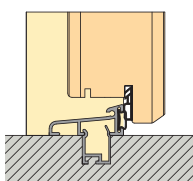

BS 1932/1933

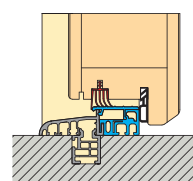

BKV 70

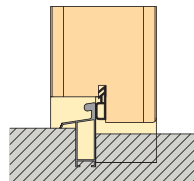

BS 1513

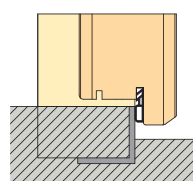

kotnik 40/40

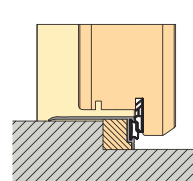

RS 60

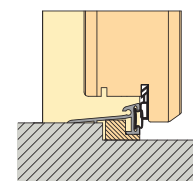

BS 1932 - 8mm

## DRŽALA nerjaveče jeklo

možna izvedba zaključka držala



A 01

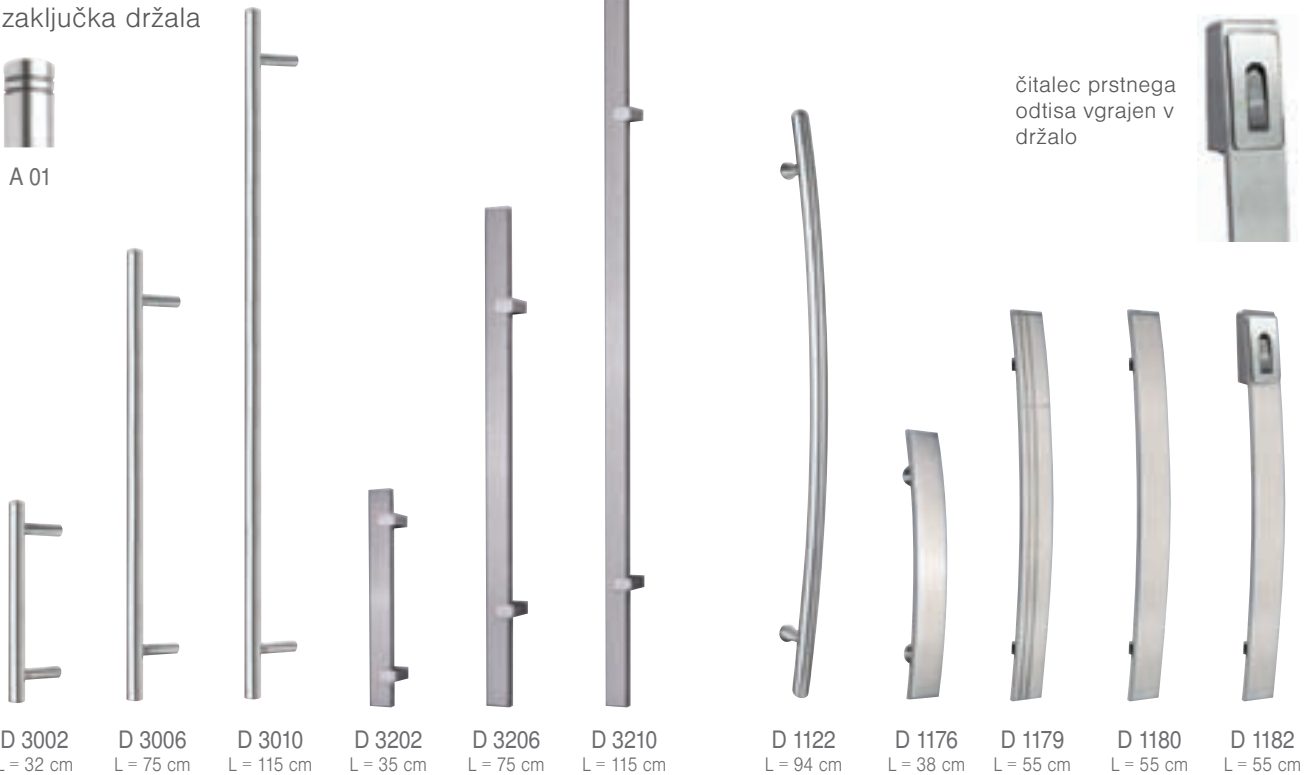

čitalec prstnega odtisa vgrajen v držalo



D 3002 L = 32 cm    D 3006 L = 75 cm    D 3010 L = 115 cm    D 3202 L = 35 cm    D 3206 L = 75 cm    D 3210 L = 115 cm    D 1122 L = 94 cm    D 1176 L = 38 cm    D 1179 L = 55 cm    D 1180 L = 55 cm    D 1182 L = 55 cm

Ostale standardne dolžine držal: 55, 95, 135, 150, 180, 200 cm

### VAROVALO ODPIRANJA



Ozka reža preprečuje vstop nezaželenim osebam. Zaklenjeno varovalo lahko iz zunanje strani odklenemo s ključem.

### TIPKOVNICA za električno odpiranje vrat



tip: INOX 75 11 96  
12V DC

### ODKLEPANJE VRAT S PRSTNIM ODTISOM (zunaj držalo ali fiksni gumb)



Čitalec prstnega odtisa tip EKEY Home Integra vgrajen v vratno krilo. (99 spominskih mest)

Ključavnica G.U-SECURITY AUTOMATIC s tritočkovnim avtomatskim zaklepanjem pri zapiranju vrat.

Elektromotor v vratnem krilu za odklepanje.

Možnost odpiranja in odklepanja s ključem.

Možnost blokade sistema z zaklepanjem s ključem (pri daljši odsotnosti uporabnika).

Mehanizem omogoča odpiranje vrat s kljuko z notranje strani.

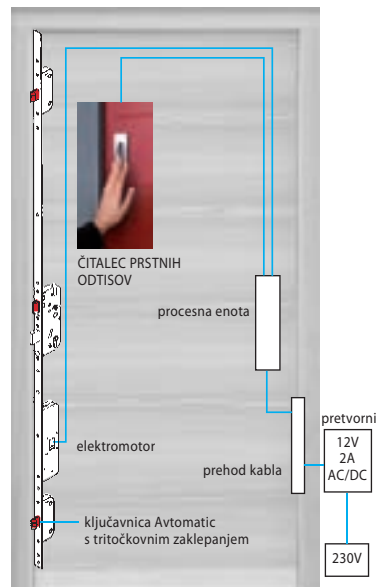

**PORTEO.** Napredno odpiranje in zapiranje.



priklop na 230 V



stikalo



daljinec



el. odpiralo



## KLJUKE



ALU 1  
kljuka / kljuka  
ALU 2  
gumb / kljuka



M 1  
kljuka / kljuka  
M 2  
gumb / kljuka



MB 1  
kljuka / kljuka  
MB 2  
gumb / kljuka



A 1  
kljuka / kljuka  
A 2  
gumb / kljuka



E 1  
kljuka / kljuka  
E 2  
gumb / kljuka



E 3



E 4



E 6



E 7



E 8



E 5 gumb  
fiksni ali vrtljivi

## DODATKI



varnostna rozeta



varnostna rozeta  
s pokritim cilindrom



električno odpiralo  
standard  
6-12V AC/DC

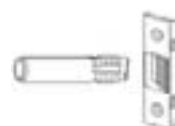

varovalo pri  
nasadilih

## CILINDRI



K 1



K 1/G

standardni cilindri, 3 ključiči



K 5 BKS



K 5/G BKS

varnostni cilindri + registracijska varnostna kartica,  
6 ključev



KABA Expert



KABA Expert/G

varnostni cilindri + registracijska varnostna kartica,  
5 ključev

## SAMOZAPIRALA

BOXER  
skrito



TS 300  
TS 500  
vidno







# PREGLED MODELOV

## PROGRAM TREND



TREND 102  
stran 4



TREND 103  
stran 4

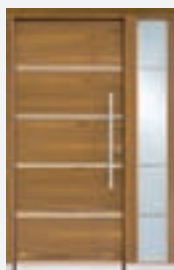

TREND 105  
stran 5



TREND 106  
stran 10



TREND 110 E16  
stran 6



TREND 110 U5  
stran 6

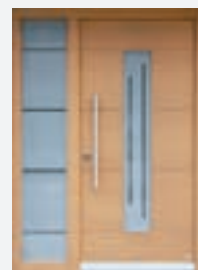

TREND 110 U16  
stran 6



TREND 125  
stran 6



TREND 126  
stran 12



TREND 128  
stran 12



TREND 129  
stran 4



TREND 130  
stran 12



TREND 131  
stran 8



TREND 135  
stran 4



TREND 170  
stran 4

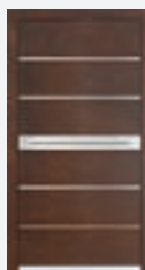

TREND 175  
stran 4



TREND 176  
stran 10

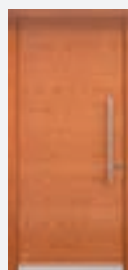

TREND 180 P  
stran 4



TREND 180  
stran 8



TREND 185  
stran 7



TREND 188  
stran 8

## PROGRAM RUSTIKAL



HT 303  
stran 14

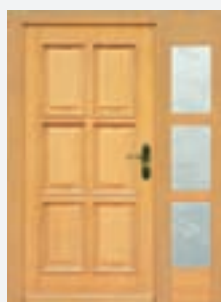

HT 306  
stran 14



HT 368  
stran 14

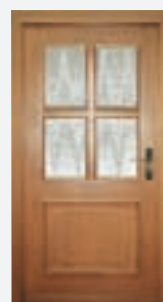

HT 384  
stran 14



HT 573  
stran 14

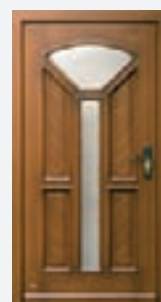

HT 603  
stran 15



TREND 111 U16  
stran 6



TREND 113  
stran 4

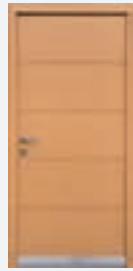

TREND 115 U10  
stran 6



TREND 115 U5  
stran 6



TREND 120  
stran 11

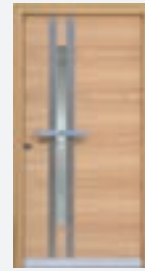

TREND 121  
stran 9



TREND 122  
stran 12



TREND 145  
stran 10

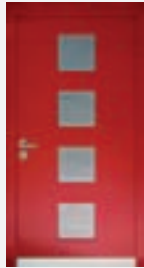

TREND 146  
stran 8



TREND 150  
stran 10



TREND 151  
stran 12



TREND 155  
stran 12

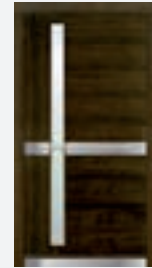

TREND 160  
stran 8

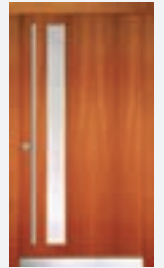

TREND 165  
stran 8



TREND 190  
stran 4



TREND 201  
stran 8



TREND 220  
stran 13

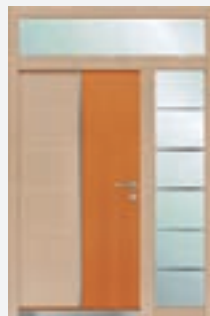

TREND 221  
stran 6



TREND 306  
stran 10



TREND 319  
stran 8



TREND 410  
stran 10

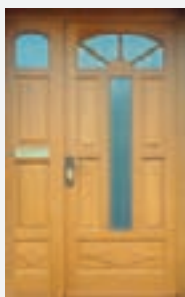

HT 611  
stran 14

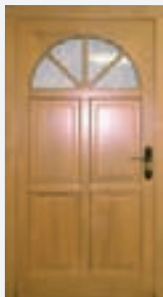

HT 621  
stran 14

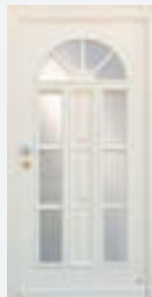

HT 623  
stran 14



HT 806  
stran 14

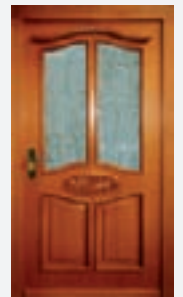

HT 902  
stran 14



### **Salon Ljubljana**

Šmartinska c. 106  
1000 Ljubljana

tel.: 01 600 80 30  
fax: 01 600 80 31

salon.lj@int-vrata.si  
**www.int-vrata.si**

### **INT vrata d.o.o. Salon Gorenja vas**

Todraž 11  
4224 Gorenja vas

tel.: 04 510 54 00  
fax: 04 510 54 01

info@int-vrata.si  
**www.int-vrata.si**



EN 14351-1:2006  
2011